

Features

- 1.28 gpf (4.8 lpf).
- Left-hand Polished Chrome trip lever.
- Coordinates with other products in the Kelston collection.
- Combines with the K-32809 bowl to create a complete K-32810 toilet.

Technology

- AquaPiston® canister optimizes the flow out of the tank, harnessing gravity and the natural powerful reducing cascade of water to increase the power and effectiveness of the flush.
- Easy-to-flush canister design requires less force to actuate than a 3" (76 mm) flapper, and has 90% less exposed seal material which resists conditions that cause wear, tear, shrinkage and swelling.

Installation

- Supply line sold separately.



Codes/Standards

ASME A112.19.2/CSA B45.1

KOHLER® Toilets and Seats Limited Warranty

See website for detailed warranty information.

Available Colors/Finishes

Color tiles intended for reference only.

Color	Code	Description
-------	------	-------------

	0	
--	---	--

	96	
--	----	--

	7	
--	---	--

KOHLER®

Kelston®
1.28 gpf toilet tank, left-hand trip lever
K-32808

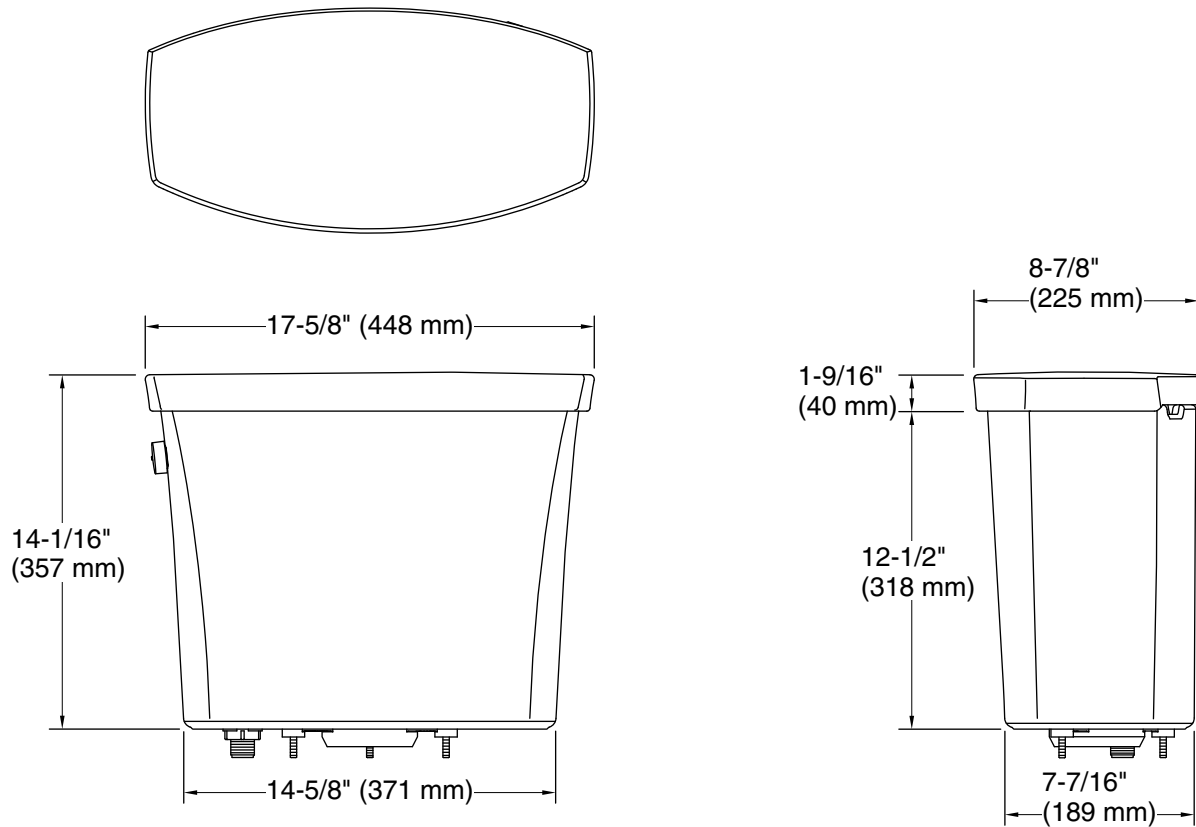

Technical Information

All product dimensions are nominal.

Toilet type: Bowl-mount

Flush type: AquaPiston

Water Consumption

Full: 1.28 gpf (4.8 lpf)

Fixture Supply Requirements

Min static pressure: 15 psi (103.4 kPa)

Max static pressure: 80 psi (551.6 kPa)

Notes

Install this product according to the installation instructions.

1-800-4KOHLER (1-800-456-4537)

Kohler Co. reserves the right to make revisions without notice to product specifications.

For the most current Specification Sheet, go to www.kohler.com.

10-4-2022 23:26 - US/CA

THE BOLD LOOK
OF **KOHLER®**